

Data Sheet

# Hermetic filter drier Type **DML** and **DCL**

For uniflow liquid line



All ELIMINATOR® driers have a solid core with binding material held to an absolute minimum.

There are two types of ELIMINATOR® cores. Type DML driers have a core composition of 100% Molecular Sieve, while type DCL contain 80% Molecular Sieve with 20% activated alumina.

ELIMINATOR® type DML driers are designed for applications requiring the highest moisture capacity.

ELIMINATOR® type DCL driers are designed for applications requiring high moisture capacity and acid adsorption capacity.

Available with solder (cu-plated steel connectors) and flare connections.

For other connections please contact your Danfoss Sales Representative.

## Features

### The Core type DML

- 100% Molecular Sieve core
- High drying capacity minimizing the risk of acid formation (hydrolysis)

### The Core type DCL

- 80% Molecular Sieve with 20% activated alumina
- Perfect core blend for systems that operate at high condensing temperatures and require high drying capacity

### The Shell

- PED approved for PS 46 bar
- Available with solder (Cu-plated steel connectors) and flare connections
- Corrosion resistant powder-painted finish. Special coating for marine applications available upon request
- Allows installation with any orientation provided the arrow is in the flow direction
- Available in sizes 3 – 75 cubic inches

### The Filter

- 25 µm (0.001 in.) filter provides high retention with minimal pressure drop
- Thermally stable up to 120 °C

**Application**

**Intro-diagram**

ELIMINATOR® Hermetic filter driers protect refrigeration and air-conditioning systems from moisture, acids, and solid particles.

With these contaminants eliminated, systems are safer from harmful chemical reactions and from abrasive impurities.

Figure 1: Application

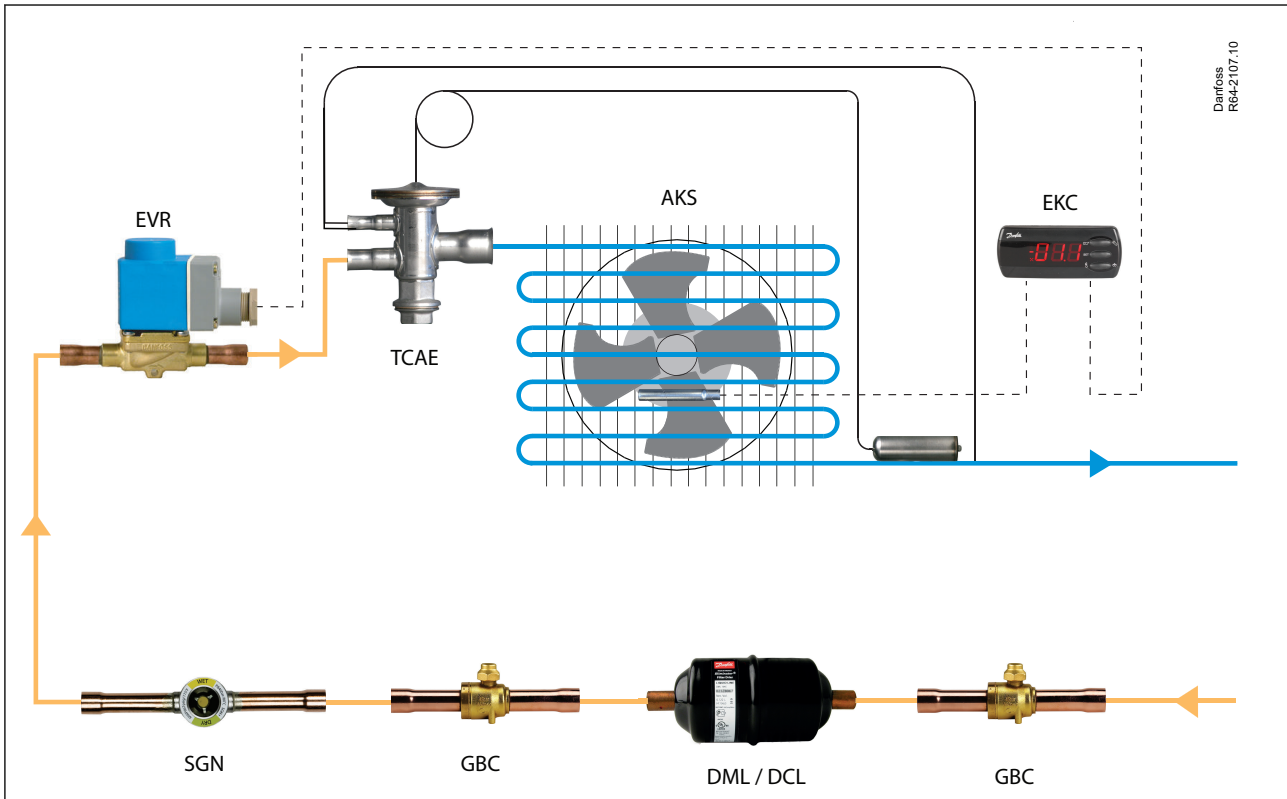

**DML Filter drier**

Recommended for use with R134a, R404A, R32,R410A,R407C, R23, R600, R600a,R1234yf, R1234ze, R407f,R290, R452A,R444B, R449A, R448A and R450A refrigerants. Will not deplete oil additives

**DCL Filter Drier**

Recommended for use with Applicable to R22, R134a, R404A, R32,R410A, R407C, R23, R600, R600a,R1234yf, R1234ze, R407f, R290, R452A,R444B, R449A, R448A and R450A refrigerants

## Product specification

### Technical data

Table 1: Technical data

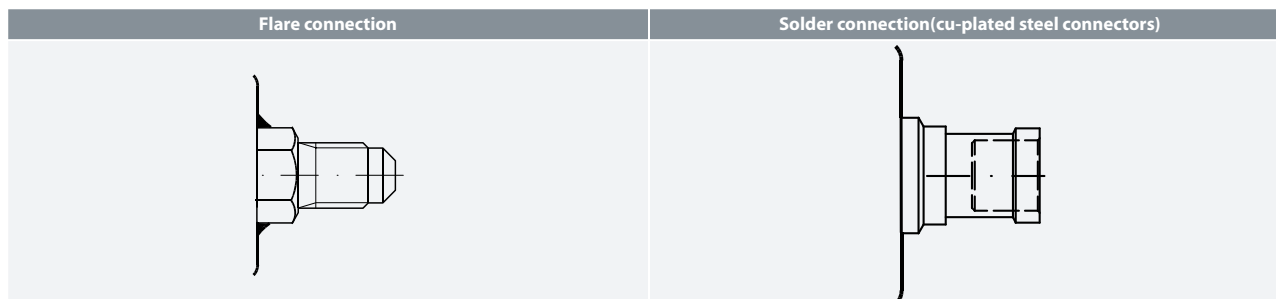

Table 2: Surface and volume

Filter	Solid core surface[cm <sup>2</sup> ]	Solid core volume[cm <sup>3</sup> ]	Filter drier volume (shell volume)[l]	Filter drier volume (net volume)[l]
DML/DCL 03	82	29	0.08	0.051
DML/DCL 05	95	35	0.12	0.085
DML/DCL 08	131	56	0.17	0.114
DML/DCL 16	220	134	0.36	0.226
DML/DCL 30	378	256	0.72	0.464
DML/DCL 41	510	350	0.97	0.62
DML/DCL 60	756	513	1.34	0.827
DML/DCL 75	1019	702	1.81	1.108

Table 3: Acid capacity

Filter	Acid capacity <sup>(1)</sup> [g]
DCL 03	0.5
DCL 05	0.8
DCL 08	1.3
DCL 16	2.9
DCL 30	6.1
DCL 41	8.3
DCL 60	12.2
DCL 75	16.6

<sup>(1)</sup> Adsorption capacity of oleic acid at 0.05 TAN (Total Acid Number).

Temperature range:

-40 – 70 °C

Maximum working pressure:

PS 46 bar

### Conversions

$$\text{Drops of water} = \frac{[1 \text{ kg of refrigerant} \times (\text{Initial PPM of water} - \text{Final PPM of water})]}{50}$$

See ARI standard 710-86 for recommended initial and final PPM values for different refrigerants.

### Identification

Table 4: Identification

Type	Codes	Description
Filter drier	D	Drier
Solid core	C	80% Molecular Sieve / 20% activated alumina
	M	100% Molecular Sieve core
Application	L	Liquid line

## Hermetic filter drier Type DML and DCL

Type	Codes	Description
Size (volume)	3	3 in. <sup>3</sup>
	5	5 in. <sup>3</sup>
	8	8 in. <sup>3</sup>
	16	16 in. <sup>3</sup>
	30	30 in. <sup>3</sup>
	38	38 in. <sup>3</sup>
	41	41 in. <sup>3</sup>
	60	60 in. <sup>3</sup>
Connection (filter connection in 1/8 of an inch increments)	75	75 in. <sup>3</sup>
	2	1/4 in. / 6 mm
	2.5	5/16 in. / 8 mm
	3	3/8 in. / 10 mm
	4	1/2 in. / 12 mm
	5	5/8 in. / 16 mm
	6	3/4 in. / 18 (19) mm
	7	7/8 in. / 22 mm
Connection type	9	1 1/8 in. / 28 mm
	(blank)	Flare connection
	s	Solder connection

### Example for type codes

D	C	L	05	3	s
D	Filter drier				
C	Solid core				
L	Application				
05	Size (volume)				
3	Connection (filter connection in 1/8 of an inch increments)				
s	Connection type				

### Selection

Type selection is made considering the application

Table 5: Selection

Refrigerant and oil types		DCL	DML
Refrigerant	HFO	Recommended	Recommended
	HC <sup>(1)</sup>	Recommended	Recommended
	HFC	Recommended	Recommended
	HCFC	Recommended	Recommended
Oil	Mineral or AB	Recommended	Recommended
	POE or PAG, pure	Recommended	Recommended
	POE or PAG, with additives	Not recommended <sup>(2)</sup>	Recommended

<sup>(1)</sup> Only solder versions (cu-plated / pure copper) and connection sizes below 25 mm are approved for flammable refrigerants now.

<sup>(2)</sup> DCL Hermetic filter driers contain activated alumina, which is a polar material used for acid adsorption. Many oil additives are also polar substances and can be adsorbed by the activated alumina, rendering them useless, and reducing the drier's acid capacity, though this is not harmful to the system.

### Filter drier selection based on capacity calculation

Drier selection based on capacities and refrigerants, please refer to Coolselector<sup>®</sup>2. Rated and extended capacities are calculated with the Coolselector<sup>®</sup>2 calculation engine to ARI standards with the ASEREP equations based on laboratory measurements of selected valves.

Download Coolselector®2 for free at [coolselector.danfoss.com](http://coolselector.danfoss.com).

## Design

Table 6: Design

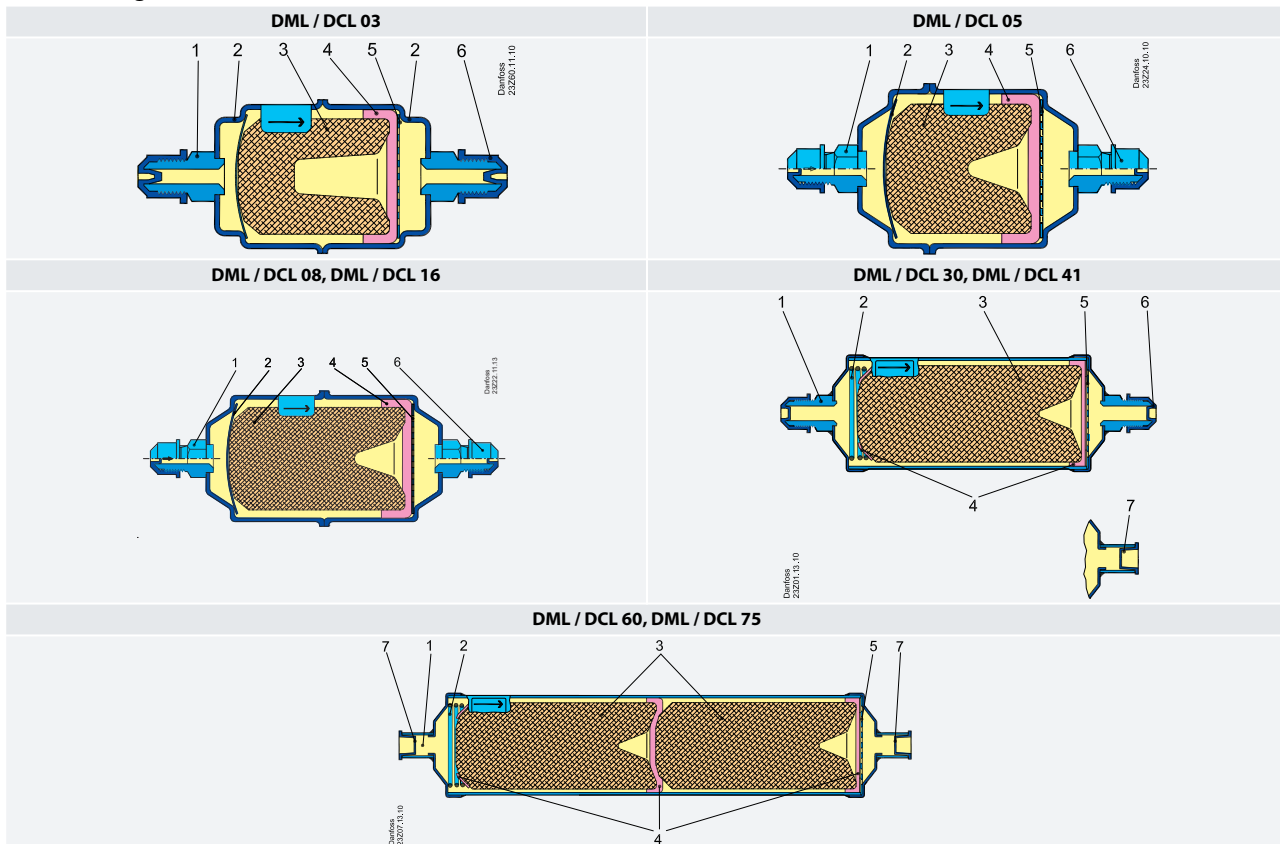

1	Inlet	5	Perforated plate
2	Spring	6	Seal cap, flare connection
3	Solid core	7	Seal cap, solder connection
4	Polyester mat		

The relatively large diameter of the hermetic filter drier means that the liquid flow velocity is suitably low and the pressure drop minimal.

Powder formation is eliminated because the solid core grains are bonded and cannot move against each other.

## Dimensions and weights

### Flare connections

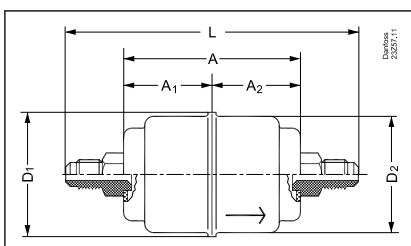

## Hermetic filter drier Type DML and DCL

Type	A	A1	A2	L	D1	D2	Net weight
	[mm]	[mm]	[mm]	[mm]	[mm]	[mm]	[Kg]
DCL / DML 032	66	33	33	110	46	43	0.17
DCL / DML 033	66	33	33	123	46	43	0.19

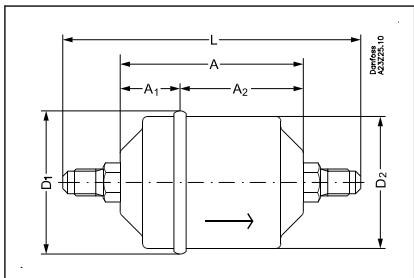

Type	A	A1	A2	L	D1	D2	Net weight
	[mm]	[mm]	[mm]	[mm]	[mm]	[mm]	[Kg]
DCL / DML 052	75	24.5	50.5	119	58	54	0.24
DCL / DML 053	75	24.5	50.5	132	58	54	0.27

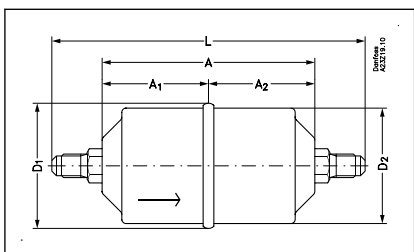

Type	A	A1	A2	L	D1	D2	Net weight
	[mm]	[mm]	[mm]	[mm]	[mm]	[mm]	[Kg]
DCL / DML 082	101	50.5	50.5	145	58	54	0.31
DCL / DML 083	101	50.5	50.5	158	58	54	0.35
DCL / DML 084	101	50.5	50.5	166	58	54	0.37
DCL / DML 085	101	50.5	50.5	175	58	54	0.4
DCL / DML 162	110	55	55	154	80	76	0.65
DCL / DML 163	110	55	55	167	80	76	0.67
DCL / DML 164	110	55	55	175	80	76	0.74
DCL / DML 165	110	55	55	184	80	76	0.74
DCL / DML 166	110	55	55	182	80	76	0.84

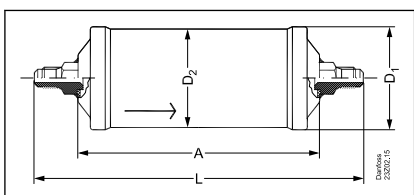

Type	A	L	D1	D2	Net weight
	[mm]	[mm]	[mm]	[mm]	[Kg]
DCL / DML 303	186	243	80	76	1.28
DCL / DML 304	186	251	80	76	1.32
DCL / DML 305	186	260	80	76	1.35
DCL / DML 306	186	258	80	76	1.45
DML 385	151	225	93	89	1.59
DCL / DML 413	187	244	93	89	1.79
DCL / DML 414	187	252	93	89	1.82
DCL / DML 415	187	261	93	89	1.87

## Hermetic filter drier Type DML and DCL

### Solder connection (cu-plated steel connectors)

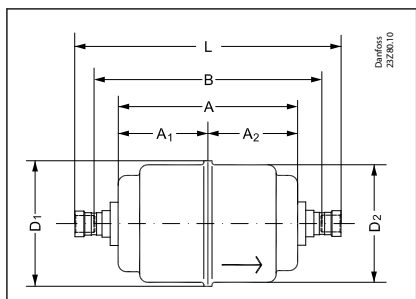

Type	A	A1	A2	B	L	D1	D2	Net weight
	[mm]	[mm]	[mm]	[mm]	[mm]	[mm]	[mm]	[Kg]
DCL / DML 032s	66	33	33	84	98	46	43	0.17
DCL / DML 032.5s	66	33	33	85	101	46	43	0.16
DCL / DML 033s	66	33	33	86	104	46	43	0.16
DCL / DML 034s	66	33	33	84	108	46	43	0.16

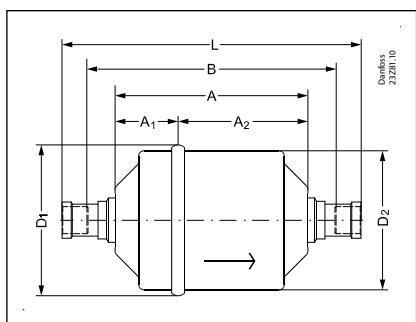

Type	A	A1	A2	B	L	D1	D2	Net weight
	[mm]	[mm]	[mm]	[mm]	[mm]	[mm]	[mm]	[Kg]
DCL / DML 052s	75	24.5	50.5	93	107	58	54	0.24
DCL / DML 052.5s	75	24.5	50.5	94	110	58	54	0.24
DCL / DML 053s	75	24.5	50.5	95	113	58	54	0.23
DCL / DML 054s	75	24.5	50.5	97	117	58	54	0.24
DCL / DML 055s	75	24.5	50.5	101	125	58	54	0.26

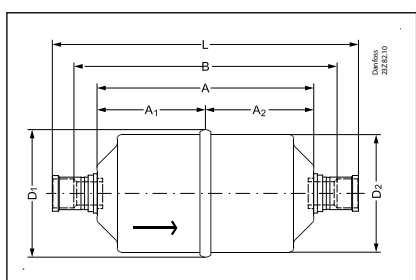

Type	A	A1	A2	B	L	D1	D2	Net weight
	[mm]	[mm]	[mm]	[mm]	[mm]	[mm]	[mm]	[Kg]
DCL / DML 082s	101	50.5	50.5	119	133	58	54	0.3
DCL / DML 082.5s	101	50.5	50.5	120	136	58	54	0.3
DCL / DML 083s	101	50.5	50.5	121	139	58	54	0.3
DCL / DML 084s	101	50.5	50.5	123	143	58	54	0.31
DCL / DML 085s	101	50.5	50.5	127	151	58	54	0.32
DCL / DML 162s	110	55	55	128	142	80	76	0.64
DCL / DML 162.5s	110	55	55	129	145	80	76	0.64



## Hermetic filter drier Type DML and DCL

Type	A	A1	A2	B	L	D1	D2	Net weight
	[mm]	[mm]	[mm]	[mm]	[mm]	[mm]	[mm]	[Kg]
DCL / DML 163s	110	55	55	130	148	80	76	0.65
DCL / DML 164s	110	55	55	132	152	80	76	0.65
DCL / DML 165s	110	55	55	136	160	80	76	0.66
DCL / DML 166s	110	55	55	136	164	80	76	0.69
DCL / DML 167s	110	55	55	136	170	80	76	0.7

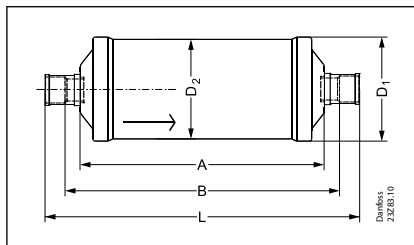

Type	A	B	L	D1	D2	Net weight
	[mm]	[mm]	[mm]	[mm]	[mm]	[Kg]
DCL / DML 303s	186	206	224	80	76	1.28
DCL / DML 304s	186	208	228	80	76	1.26
DCL / DML 305s	186	212	236	80	76	1.27
DCL / DML 306s	186	212	240	80	76	1.3
DCL / DML 307s	186	212	246	80	76	1.32
DCL / DML 309s	186	196	250	80	76	1.37
DCL / DML 414s	187	209	229	93	89	1.84
DCL / DML 415s	187	213	237	93	89	1.85
DCL / DML 417s	187	213	247	93	89	1.88
DCL / DML 419s	187	197	251	93	89	1.9
DCL / DML 604s	337	359	379	80	76	2.98
DCL / DML 606s	337	363	391	80	76	2.21
DCL / DML 607s	337	363	397	80	76	2.21
DCL / DML 609s	337	347	401	80	76	2.32
DCL / DML 757s	338	364	398	93	89	3.1
DCL / DML 759s	338	348	402	93	89	3.1

## Ordering

### Type DCL Flare

Figure 2: DCL Flare

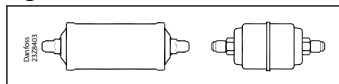

Table 7: DCL Flare

Type	Connection size		Multi pack		Industrial pack for OEM only	
	[in.]	[mm]	Code no.	Qty.	Code no.	Qty.
DCL 032	1/4	6	023Z5000 <sup>(1)(2)</sup>	32	–	–
DCL 032	1/4	6	023Z5075 <sup>(2)</sup>	32	–	–
DCL 033	3/8	10	023Z5001 <sup>(1)(2)</sup>	32	–	–
DCL 033	3/8	10	023Z5089 <sup>(2)</sup>	32	–	–
DCL 052	1/4	6	023Z5002 <sup>(2)</sup>	24	023Z8002 <sup>(2)</sup>	16
DCL 053	3/8	10	023Z5003 <sup>(2)</sup>	24	023Z8003 <sup>(2)</sup>	16
DCL 082	1/4	6	023Z5004 <sup>(2)</sup>	24	023Z8004 <sup>(2)</sup>	16
DCL 083	3/8	10	023Z5005 <sup>(2)</sup>	24	023Z8005 <sup>(2)</sup>	16
DCL 084	1/2	12	023Z5006 <sup>(2)</sup>	24	–	–
DCL 162	1/4	6	023Z5007 <sup>(2)</sup>	12	023Z8007 <sup>(2)</sup>	12
DCL 163	3/8	10	023Z5008 <sup>(2)</sup>	12	023Z8008 <sup>(2)</sup>	12
DCL 164	1/2	12	023Z5009 <sup>(2)</sup>	12	023Z8009 <sup>(2)</sup>	12
DCL 165	5/8	16	023Z5010 <sup>(2)</sup>	12	023Z8010 <sup>(2)</sup>	12
DCL 166	3/4	19	023Z5011 <sup>(2)</sup>	12	–	–
DCL 303	3/8	10	023Z0012	8	–	–
DCL 304	1/2	12	023Z0013	8	023Z3013	8
DCL 305	5/8	16	023Z0014	8	023Z3014	8
DCL 306	3/4	19	023Z0156	8	–	–
DCL 414	1/2	12	023Z0102	8	–	–
DCL 415	5/8	16	023Z0103	8	–	–

<sup>(1)</sup> Wire mesh in filter drier outlet

<sup>(2)</sup> India make is available with code 023ZXXXX91

### Type DML Flare

Figure 3: DML Flare

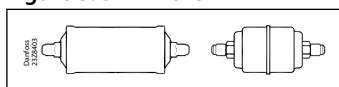

Table 8: DML Flare

Type	Connection size		Multi pack		Industrial pack for OEM only	
	[in.]	[mm]	Code no.	Qty.	Code no.	Qty.
DML 032	1/4	6	023Z5035 <sup>(1)(2)</sup>	32	023Z8035 <sup>(1)(2)</sup>	28
DML 033	3/8	10	023Z5036 <sup>(1)(2)</sup>	32	023Z8036 <sup>(1)</sup>	28
DML 033	3/8	10	023Z5090 <sup>(2)</sup>	32	–	–
DML 052	1/4	6	023Z5037 <sup>(2)</sup>	24	023Z8037 <sup>(2)</sup>	16
DML 053	3/8	10	023Z5038 <sup>(2)</sup>	24	023Z8038 <sup>(2)</sup>	16
DML 082	1/4	6	023Z5039 <sup>(2)</sup>	24	023Z8039 <sup>(2)</sup>	16
DML 083	3/8	10	023Z5040 <sup>(2)</sup>	24	023Z8040 <sup>(2)</sup>	16
DML 084	1/2	12	023Z5041 <sup>(2)</sup>	24	023Z8041 <sup>(2)</sup>	16
DML 085	5/8	16	023Z5073 <sup>(2)</sup>	24	–	–
DML 162	1/4	6	023Z5042 <sup>(2)</sup>	12	023Z8042 <sup>(2)</sup>	12
DML 163	3/8	10	023Z5043 <sup>(2)</sup>	12	023Z8043 <sup>(2)</sup>	12
DML 164	1/2	12	023Z5044 <sup>(2)</sup>	12	023Z8044 <sup>(2)</sup>	12
DML 165	5/8	16	023Z5045 <sup>(2)</sup>	12	023Z8045 <sup>(2)</sup>	12
DML 166	3/4	19	023Z5046 <sup>(2)</sup>	12	–	–

## Hermetic filter drier Type DML and DCL

Type	Connection size		Multi pack		Industrial pack for OEM only	
	[in.]	[mm]	Code no.	Qty.	Code no.	Qty.
DML 303	3/8	10	023Z0049	8	023Z3049	8
DML 304	1/2	12	023Z0050	8	023Z3050	8
DML 305	5/8	16	023Z0051	8	023Z3051	8
DML 306	3/4	19	023Z0193	8	023Z3193	8
DML 385	5/8	16	023Z0189	8	–	–
DML 413	3/8	10	023Z0108	8	–	–
DML 414	1/2	12	023Z0109	8	–	–
DML 415	5/8	16	023Z0110	8	023Z3110	6
DML 416	3/4	19	023Z0195	8	023Z0210	6

<sup>(1)</sup> Wire mesh in filter drier outlet

<sup>(2)</sup> India make is available with code 023ZXXXX91

## Type DCL Solder (cu-plated steel connectors)

Figure 4: DCL Solder

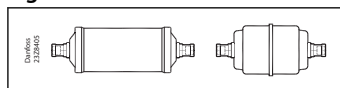

Table 9: DCL Solder

Type	Conn. Size [in.]	Multi pack		Industrial pack for OEM only		Conn. Size [mm]	Multi pack		Industrial pack for OEM only	
		Code no.	Qty.	Code no.	Qty.		Code no.	Qty.	Code no.	Qty.
DCL 032s	1/4	023Z4501 <sup>(1)</sup>	32	023Z4801 <sup>(1)</sup>	28	6	023Z4500 <sup>(1)</sup>	32	023Z4800 <sup>(1)</sup>	28
DCL 032.5s	5/16	023Z4502 <sup>(1)</sup>	32	023Z4803 <sup>(1)</sup>	28	8	–	–	–	–
DCL 033s	3/8	023Z4504 <sup>(1)</sup>	32	–	–	10	023Z4503 <sup>(1)</sup>	32	–	–
DCL 052s	1/4	023Z4506 <sup>(1)</sup>	24	023Z4805 <sup>(2)</sup>	16	6	023Z4505 <sup>(1)</sup>	24	023Z4804 <sup>(1)</sup>	16
DCL 052s	5/16	023Z4507 <sup>(1)</sup>	24	–	–	10	–	–	–	–
DCL 053s	3/8	023Z4509 <sup>(1)</sup>	24	023Z4807 <sup>(1)</sup>	16	10	023Z4508 <sup>(1)</sup>	24	–	–
DCL 082s	1/4	023Z4511 <sup>(1)</sup>	24	–	–	6	023Z4510 <sup>(1)</sup>	24	–	–
DCL 082s	5/16	023Z4512 <sup>(1)</sup>	28	–	–	6	–	–	–	–
DCL 083s	3/8	023Z4514 <sup>(1)</sup>	24	023Z4811 <sup>(1)</sup>	16	10	023Z4513 <sup>(1)</sup>	24	023Z4809 <sup>(1)</sup>	16
DCL 084s	1/2	023Z4516 <sup>(1)</sup>	24	023Z4813 <sup>(1)</sup>	16	12	023Z4515 <sup>(1)</sup>	24	–	–
DCL 162s	1/4	023Z4518 <sup>(1)</sup>	12	–	–	6	023Z4517 <sup>(1)</sup>	12	–	–
DCL 163s	3/8	023Z4521 <sup>(1)</sup>	12	–	–	10	023Z4519 <sup>(1)</sup>	12	023Z4814	12
DCL 164s	1/2	023Z4523 <sup>(1)</sup>	12	023Z4815 <sup>(1)</sup>	12	12	023Z4522 <sup>(1)</sup>	12	–	–
DCL 165s	5/8	023Z4524 <sup>(1)</sup>	12	023Z4816 <sup>(1)</sup>	12	12	–	–	–	–
DCL 166s	3/4	023Z4525 <sup>(1)</sup>	12	–	–	–	–	–	–	–
DCL 167s	7/8	023Z4526 <sup>(1)</sup>	12	–	–	–	–	–	–	–
DCL 303s	3/8	023Z4528	8	023Z4817	8	10	023Z4527	8	–	–
DCL 304s	1/2	023Z4530	8	–	–	12	023Z4529	8	–	–
DCL 305s	5/8	023Z4531	8	023Z4819	8	16	–	8	–	–
DCL 306s	3/4	023Z4533	8	–	–	18	023Z4532	8	–	–
DCL 307s	7/8	023Z4534	8	023Z4820	8	22	–	8	–	–
DCL 309s	1 1/8	023Z4536	8	–	–	28	023Z4535	8	–	–
DCL 414s	1/2	023Z4538	8	–	–	12	–	8	–	–
DCL 415s	5/8	023Z4539	8	–	–	16	–	8	–	–
DCL 417s	7/8	023Z4540	8	–	–	22	–	8	–	–
DCL 419s	1 1/8	023Z4542	8	–	–	28	023Z4541	8	–	–
DCL 604s	1/2	023Z4544	12	–	–	22	–	–	–	–
DCL 607s	7/8	023Z4545	6	–	–	22	–	–	–	–
DCL 609s	1 1/8	–	12	–	–	28	023Z4546	6	–	–
DCL 757s	7/8	023Z4548	12	–	–	22	–	–	–	–
DCL 759s	1 1/8	023Z4550	12	–	–	28	023Z4549	12	–	–

<sup>(1)</sup> India make is available with code 023ZXXXX91

## Type DML Solder (cu-plated steel connectors)

Figure 5: DML Solder

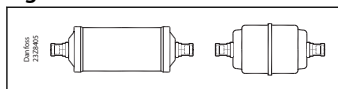

Table 10: DML Solder

Type	Conn. Size	Multi pack		Industrial pack for OEM only		Conn. Size	Multi pack		Industrial pack for OEM only	
	[in.]	Code no.	Qty.	Code no.	Qty.		[mm]	Code no.	Qty.	Code no.
DML 032s	1/4	023Z4552 <sup>(1)</sup>	32	023Z4822 <sup>(1)</sup>	28	6	023Z4551 <sup>(1)</sup>	32	023Z4821 <sup>(1)</sup>	28
DML 032.5s	5/16	023Z4553 <sup>(1)</sup>	32	023Z4823 <sup>(1)</sup>	28	8	-	-	-	-
DML 033s	3/8	023Z4555 <sup>(1)</sup>	32	023Z4825 <sup>(1)</sup>	28	10	023Z4554 <sup>(1)</sup>	32	023Z4824 <sup>(1)</sup>	28
DML 034s	1/2	023Z4556 <sup>(1)</sup>	32	-	-	12	023Z4557	32	-	-
DML 052s	1/4	023Z4559 <sup>(1)</sup>	24	023Z4849 <sup>(1)</sup>	16	6	023Z4558 <sup>(1)</sup>	24	023Z4826 <sup>(1)</sup>	16
DML 052.5s	5/16	023Z4560 <sup>(1)</sup>	24	-	-	6	-	-	-	-
DML 053s	3/8	023Z4562 <sup>(1)</sup>	24	023Z4828 <sup>(1)</sup>	16	10	023Z4561	28	023Z4827 <sup>(1)</sup>	16
DML 054s	1/2	023Z4564 <sup>(1)</sup>	24	-	-	12	023Z4563 <sup>(1)</sup>	12	023Z4845 <sup>(1)</sup>	16
DML 055s	5/8	023Z4565 <sup>(1)</sup>	24	023Z4838 <sup>(1)</sup>	16	16	-	-	-	-
DML 082s	1/4	023Z4567 <sup>(1)</sup>	24	023Z4847 <sup>(1)</sup>	16	6	023Z4566 <sup>(1)</sup>	24	023Z4866 <sup>(1)</sup>	16
DML 082.5s	5/16	023Z4568	24	-	-	8	-	-	-	-
DML 083s	3/8	023Z4570 <sup>(1)</sup>	24	023Z4835 <sup>(1)</sup>	16	10	023Z4569	24	023Z4839 <sup>(1)</sup>	16
DML 084s	1/2	023Z4572 <sup>(1)</sup>	24	023Z4829 <sup>(1)</sup>	16	12	023Z4571 <sup>(1)</sup>	24	023Z4840 <sup>(1)</sup>	16
DML 085s	5/8	023Z4573 <sup>(1)</sup>	24	-	-	16	-	-	-	-
DML 162s	1/4	023Z4575 <sup>(1)</sup>	12	-	-	6	023Z4574 <sup>(1)</sup>	12	-	-
DML 163s	3/8	023Z4578 <sup>(1)</sup>	12	023Z4836 <sup>(1)</sup>	12	10	023Z4577 <sup>(1)</sup>	12	023Z4842 <sup>(1)</sup>	12
DML 164s	1/2	023Z4580 <sup>(1)</sup>	12	023Z4830 <sup>(1)</sup>	12	12	023Z4579 <sup>(1)</sup>	12	023Z4843 <sup>(1)</sup>	12
DML 165s	5/8	023Z4581 <sup>(1)</sup>	12	023Z4831 <sup>(1)</sup>	12	16	-	-	-	-
DML 166s	3/4	023Z4582 <sup>(1)</sup>	12	023Z4832 <sup>(1)</sup>	12	19	-	-	-	-
DML 167s	7/8	023Z4583 <sup>(1)</sup>	12	-	-	22	-	-	-	-
DML 303s	3/8	023Z4585	8	-	-	10	023Z4584	8	-	-
DML 304s	1/2	023Z4587	8	023Z4837	8	12	023Z4586	8	023Z4844	8
DML 305s	5/8	0023Z4588	8	023Z4833	8	16	-	-	-	-
DML 306s	3/4	023Z4589	8	023Z4848	8	19	-	-	-	-
DML 307s	7/8	023Z4590	8	023Z4834	8	22	-	-	-	-
DML 309s	1 1/8	023Z4592	8	-	-	28	023Z4591	8	-	-
DML 414s	1/2	023Z4594	8	-	-	12	023Z4593	8	-	-
DML 415s	5/8	023Z4595	8	-	-	16	-	-	-	-
DML 417s	7/8	023Z4596	8	023Z4896	6	22	-	-	-	-
DML 419s	1 1/8	023Z4598	8	023Z4898	6	28	023Z4597	8	-	-
DML 604s	1/2	023Z4600	12	-	-	12	023Z4599	12	-	-
DML 605s	1/2	-	-	-	-	18	023Z4601	6	-	-
DML 607s	7/8	023Z4602	6	023Z4902	-	22	-	-	-	-
DML 609s	1 1/8	023Z4604	12	-	-	28	023Z4603	12	-	-
DML 757s	7/8	023Z4605	12	023Z4905	4	22	-	-	-	-
DML 759s	1 1/8	023Z4607	12	023Z4907	4	28	023Z4606	12	-	-

<sup>(1)</sup> India make is available with code 023ZXXX91

## Certificates, declarations, and approvals

The list contains all certificates, declarations, and approvals for this product type. Individual code number may have some or all of these approvals, and certain local approvals may not appear on the list.

Some approvals may change over time. You can check the most current status at [danfoss.com](http://danfoss.com) or contact your local Danfoss representative if you have any questions.

**Table 11: Certificates, declarations, and approvals**

Document type	Approval authority
Manufacturer declaration for PED/ROHS/ATEX	Danfoss
UL certificate	UL
EAC document	EAC
Manufacturer declaration for china ROHS	Danfoss

**⚠ WARNING:**

Only solder versions (cu-plated / pure copper) and connection sizes below 25 mm are approved for flammable refrigerants now.

## Online support

Danfoss offers a wide range of support along with our products, including digital product information, software, mobile apps, and expert guidance. See the possibilities below.

### The Danfoss Product Store



The Danfoss Product Store is your one-stop shop for everything product related—no matter where you are in the world or what area of the cooling industry you work in. Get quick access to essential information like product specs, code numbers, technical documentation, certifications, accessories, and more.

Start browsing at [store.danfoss.com](https://store.danfoss.com).

### Find technical documentation



Find the technical documentation you need to get your project up and running. Get direct access to our official collection of data sheets, certificates and declarations, manuals and guides, 3D models and drawings, case stories, brochures, and much more.

Start searching now at [www.danfoss.com/en/service-and-support/documentation](https://www.danfoss.com/en/service-and-support/documentation).

### Danfoss Learning



Danfoss Learning is a free online learning platform. It features courses and materials specifically designed to help engineers, installers, service technicians, and wholesalers better understand the products, applications, industry topics, and trends that will help you do your job better.

Create your Danfoss Learning account for free at [www.danfoss.com/en/service-and-support/learning](https://www.danfoss.com/en/service-and-support/learning).

### Get local information and support



Local Danfoss websites are the main sources for help and information about our company and products. Find product availability, get the latest regional news, or connect with a nearby expert—all in your own language.

Find your local Danfoss website here: [www.danfoss.com/en/choose-region](https://www.danfoss.com/en/choose-region).

### Coolselector®2 - find the best components for you HVAC/R system



Coolselector®2 makes it easy for engineers, consultants, and designers to find and order the best components for refrigeration and air conditioning systems. Run calculations based on your operating conditions and then choose the best setup for your system design.

Download Coolselector®2 for free at [coolselector.danfoss.com](https://coolselector.danfoss.com).